

P/N : 388067055  
PRINTED IN KOREA

Distributed by

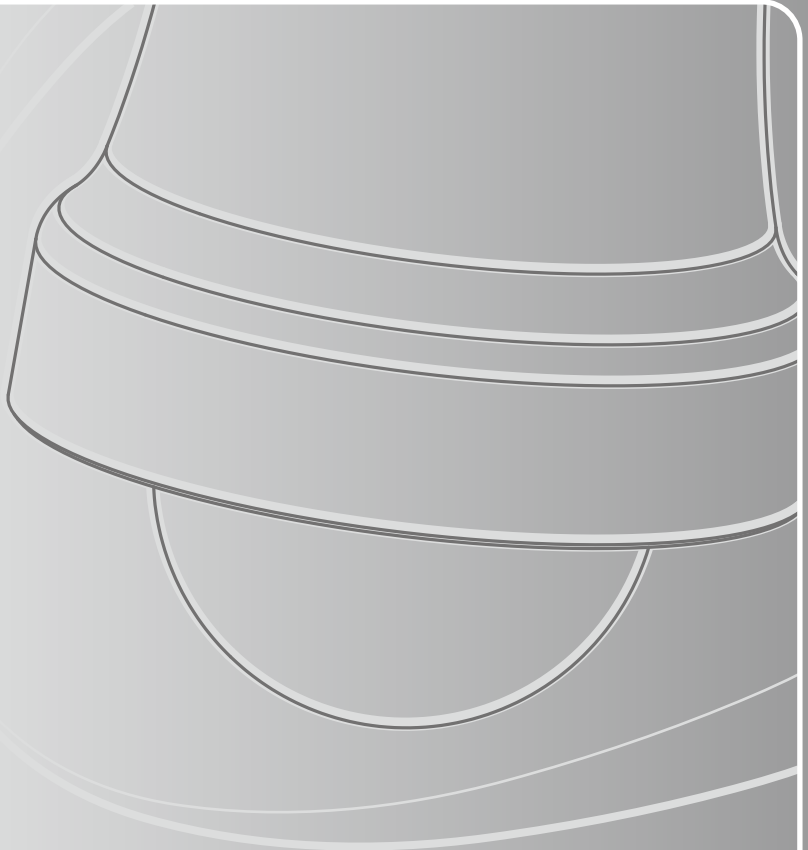

## **INSTALLATION / OPERATING MANUAL**

---

# High Speed Dome Camera

- Before attempting to connect or operate this product, please read these instructions carefully and save this manual for future use.
- The design and specifications are subject to be changed without prior notice to improve product's quality.

# TABLE OF CONTENTS

## 1. PRECAUTIONS

1.1 Important Safety Instruction .....	3p.
--	-----

## 2. GETTING STARTED

2.1 Unpacking .....	4p.
2.2 Part name .....	4p.
2.3 DIP Switch Setting .....	5p.
2.4 Cable Connection .....	6p.

## 3. INSTALLATION

3.1 Installation .....	7p.
------------------------	-----

## 4. MAIN SETUP MENU

4.1 Initialize .....	9p.
4.2 Motion Setting .....	9p.
4.3 Dome Setting .....	30p.
4.4 Clear Setting .....	38p.
4.5 Factory set .....	38p.
4.6 PTZ Reset .....	38p.
4.7 Other Quick Operating Guide .....	38p.

## 5. SPECIFICATION

5.1 Mechanism Specification .....	39p.
-----------------------------------	------

## 6. DIMENSION

6.1 DIMENSION .....	40p.
---------------------	------

## 7. CONFIGURATION

7.1 Connecting to Keyboard with DVR .....	41p.
---	------

# 1. PRECAUTIONS



## 1.1 Important Safety Instruction

---

- Read these instructions.
- Pay attention on all the warnings.
- Follow all instructions.
- Do not block any ventilation openings. Install in accordance with the manufacturer's instructions.
- Do not disassemble or insert foreign objects.
- Do not install near any heat sources such as radiation, heat registers, stoves, or other apparatus. (Including amplifiers) that produce heat.
- Do not aim the camera at the sun or any other strong light source.
- Do not install the camera in intermittent lighting environments.
- Only use attachments/accessories specified by the manufacturer.
- Use only with the cart, stand, tripod, bracket, or table specified by the manufacturer, or sold with the apparatus. When a cart is used, use caution when moving the cart/apparatus combination to avoid injury from tip-over.
- Refer all servicing to qualified service personnel. Servicing is required when the apparatus has been damaged in any way, such as power-supply cord or plug is damaged, liquid has been spilled or objects have fallen into the apparatus, the apparatus has been exposed to rain or moisture, does not operate normally, or has been dropped.
- Installation should be done only by qualified personnel and conform to all local codes.
- Installation should be done in a place strong enough to hold it.
- Use only installation methods and materials capable of supporting four times the maximum specified load.
- It is designed for indoor use only and it must not be installed where exposed to rain and moisture without additional outdoor housing and bracket.
- To prevent damage from water leakage when installing a mount outdoors on a roof or wall, apply sealant around the bolt holes between the mount and mounting surface.
- These instructions are for use by qualified service personnel only. To reduce the risk of electric shock do not perform any servicing other than that contained in the operating instructions unless you are qualified to do so.
- Only use replacement parts recommended by manufacturer. ad these instructions.

## 2. GETTING STARTED

### 2.1 Unpacking

The following parts are supplied with the outdoor speed PTZ dome system.

<Figure 1. package Components>

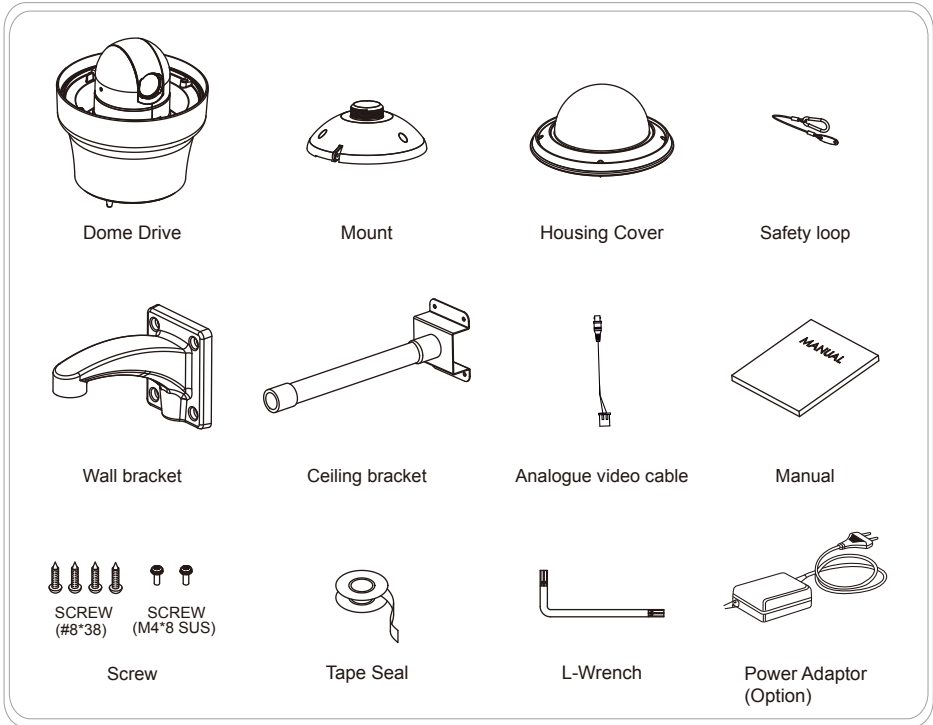

### 2.2 Part name

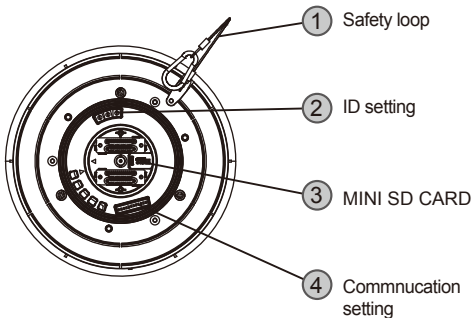

## 2.3 DIP Switch Setting

Before start up the dome camera, set the protocol and camera address and termination set with dip-switches and click-switches as shown in the below diagram.

### 1. Set the camera address (ID)

Open the top cover of the product to set camera address.



Address switch

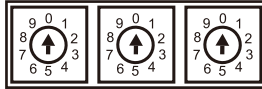

S1

S3

S4

\* ID setting is 1~255 available

S1 : 1-digit number of address

S3 : 10-digit number of address

S4 : 100-digit number of address

Ex) S4 = 1

S3 = 2

S1 = 8

The ID number is 128.

### 2. Protocol, Baudrate, Camera setting

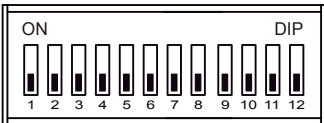

1	2	3	PROTOCOL
OFF	OFF	OFF	PELCO-D
OFF	OFF	ON	PELCO-P
OFF	ON	OFF	WTX
OFF	ON	ON	EZP
ON	OFF	OFF	NC
ON	OFF	ON	NC
ON	ON	OFF	NC
ON	ON	ON	NC

4	5	6	BAUDRATE
OFF	OFF	OFF	2400
OFF	OFF	ON	4800
OFF	ON	OFF	9600
OFF	ON	ON	19200
ON	OFF	OFF	38400
ON	OFF	ON	57600
ON	ON	OFF	115200
ON	ON	ON	NC

7	RSMODE
OFF	RS-422
ON	RS-485

9	RS LOOP
OFF	OFF
ON	ON

11	IP SELECT
OFF	IP OFF
ON	IP ON

8	NTSC/PAL
OFF	NTSC
ON	PAL

10	NC
OFF	NC
ON	NC

12	BOOTO
OFF	OFF
ON	PROGRAM MODE

### 3. Set the termination On/Off



ON : Terminated

OFF : Not terminated

The device which is connected at the end of the line must have the cable communication terminated. Without proper termination, there is potential for control signal errors.

The product have the cable communication terminated by setting the appropriate dip switch.

## 2.4 Cable connection

### 2.4.1 Power/Data communication cable connection

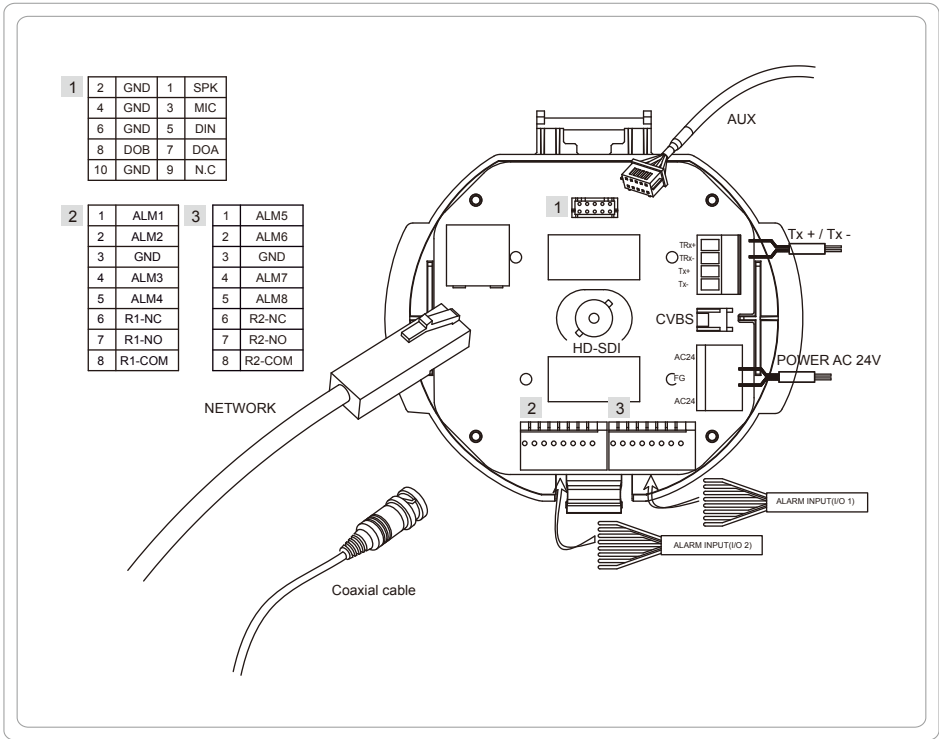

### 2.4.2 RS-485/RS-422 Connection

#### RS-422/485 connection

The PTZ can be remotely controlled by an external device or control system, such as a control keyboard or DVR, using RS-485 half-duplex, RS-422 duplex or simplex serial communication signals. Connect marked TRx+, TRx- to Tx+ and Tx- of the RS-485 control system.

If control system is RS-422, connect Tx+, Tx- of controller to Rx+ and Rx- of the PTZ Camera series. And also connect the Tx+, Tx- to Rx+, Rx- of the control device respectively. Total length of the cable for communication should not exceed 1.2Km.

### 2.4.3 HD-SDI Output connection

Connect the HD-SDI out (BNC) connector to the monitor or video input of DVR. Video cable and RS-485/422 communication cable are not provided in this product's package.



**Caution**



Do not connect the AC24V power terminal to the communication terminal.

- Power Terminal: 2PIN
- Com Terminal: 4PIN

## 3.Installation

- The following steps of installation and connection work should be done by qualified service personnel or system installers and should conform to all local codes.
- Be sure to switch the camera off before installation is completed.
- Do not install the camera near the air outlet of an air conditioner.
- Before installation, set the dome system with Dip switch on the back side of the mechanism part, and assemble the mechanism and housing according to the below instruction

### 3.1 Installation

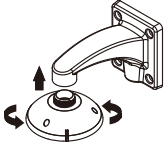

Set the mount to the wall bracket by turn it to clockwise.

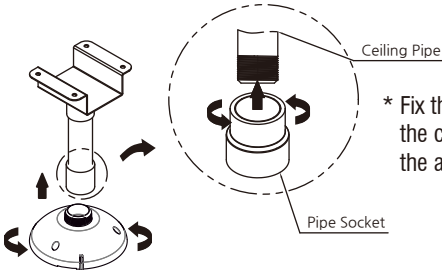

\* Fix the socket into the ceiling pipe when install the ceiling bracket. The socket is included in the accessory package.

Set the mount to the ceiling bracket by turn it to clockwise.

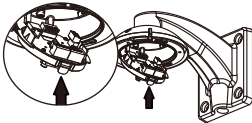

Push the knob of mount and pull down.  
Connect the cable. (See the page6)

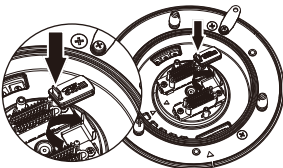

To insert or remove the SD card, open the protective cap and put up the slot cover of SD card.  
Cover the protective cap after insert the SD card to prevent foreign substance damage.

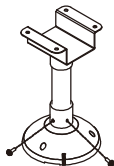
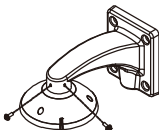

After connecting the cable, set the mount in the proper position and fix the 2 screws (M4\*8)

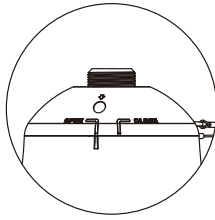
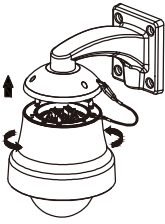

OPEN  
(Arrow is aligned)

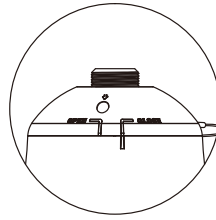

CLOSE  
(Turn the body to clockwise)

1. Connect the safety loop on the body and mount back side.
  2. Align the arrow mark in the body and mount.
  3. Fix the body by turn it to clockwise.
- \* Please check the direction of connector in the camera body and mount.

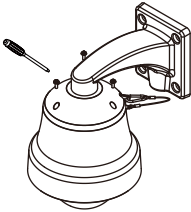

Fix the screws with camera body and mount as the left picture.

# 4. MAIN SETUP MENU

## 4.1 Initialize

When the device is powered on, you can check the address, version, protocol and video setting values.

```

INITIALIZE
PTZ ID      : 001
VERSION    : X_XX
D-OUTPUT   : 1080p30/NTSC

PROTOCOL   : PELCO-D
BAUDRATE   : 2400.N.1
CAMERA     : XX XXX_ OK
            VER: XX, XX
▷ PAN INIT  : . . . . . OK
▷ TILT INIT : . . . . . OK

▷NORMAL SETTING WAIT . .
    
```

## 4.2 Motion Setting

### 4.2.1 Preset

```

MAIN MENU
-----
MOTION ▶
DOME   ▷
CAMERA ▷
CLEAR  ▷
FACTORY SET
PTZ RESET

EXIT
<NEAR / RIGHT ▷ MOTION >
    
```

```

MOTION MENU
-----
PRESET ▶
TOUR   ▷
GROUP  ▷
SCAN   ▷
PATTERN ▷
AREA   ▷
ALARM  ▷
PRIVACY ▷
HOME POS ▷

BACK           EXIT
<NEAR / RIGHT ▷ PRESET >
    
```

The preset function is that the camera memorizes positions of the pan/tilt and zoom. This function is a representative function of the speed dome which can find memorized preset positions just by selecting the preset No. A Maximum of 255 Preset positions are toured in order.

(1) Select the Preset number

P001 : Defined Preset number / 001 : Undefined Preset number

Move :  JOYSTICK      Select : 

```

PRESET MENU
-----
NUMBER : 001
TITLE   :
FOCUS   : AUTO
POSITION SET ▶

<<FIRST TITLE SELECT>>

SAVE    CLR    BACK    EXIT
<NEAR / RIGHT ▷ PRESETNUM >
    
```

```

PRESET MENU
PRESET SELECT : 001

P001 P002 P003 P004 P005
006 007 008 009 010
011 012 013 014 015
016 017 018 019 020
021 022 023 024 025
026 027 028 029 030
031 032 033 034 035
036 037 038 039 040
041 042 043 044 045

<EXIT ▷ FOCUS NEAR >
    
```

## (2) Set the Preset TITLE

Move :  Select :  or  Delete :  or 

It's available to set the desired TITLE, displayed on the executing screen of Preset.



After the TITLE is set, push the NEAR button to exit.

## (3) Select the focus mode for Preset

① Select the Focus menu



② Move and set the Focus Menu



On focus menu, there are 3 modes :  
**AUTO, MANUAL, ONESHT.** It allows detailed settings for the preset.

## (4) Define the Preset position

① Select the Position menu



② Move and set the position



③ Set & Back

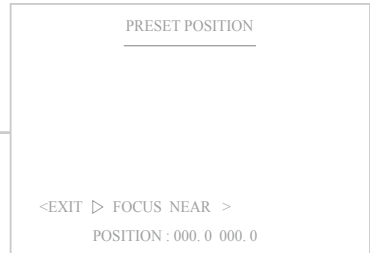
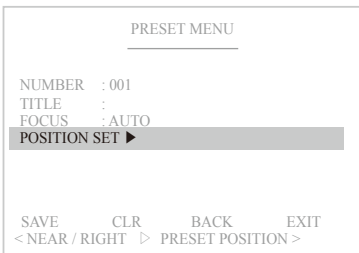

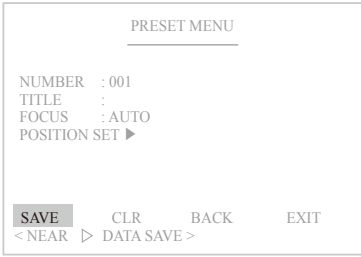

- (5) “Save” above setting Pattern data to the memory.
- (6) “CLR” means above setting Pattern data will not be saved and be cleared.
- (7) “BACK” means it goes back to the previous menu :Motion.
- (8) “EXIT” means it goes out of MENU.

## 4.2.2 Tour

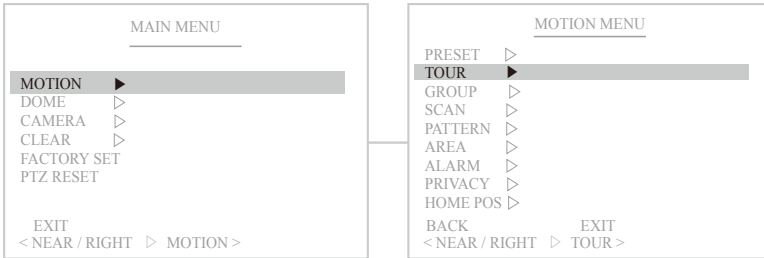

The Tour function consists of several presets run by turn. It is also adjusts the moving speed (1~63 step) and dwell time (1~99secs). Maximum of 8 Tour functions are toured in order.

(※ 1 Tour can be set for 15 presets.)

(1) Select the Tour number

T01 : Defined Tour number / 01 : Undefined Tour number

Move : Select :

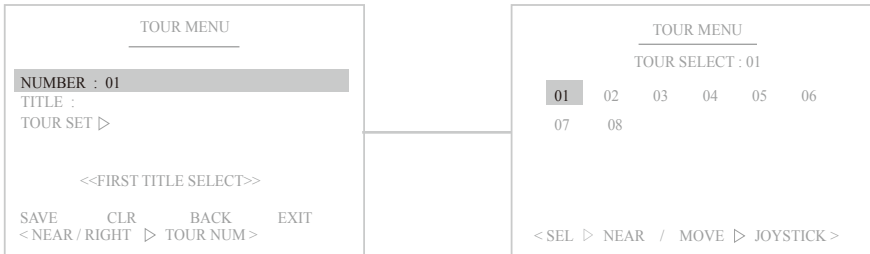

(2) Set the Tour TITLE

Move : Select : or Delete : or

It's available to set the desired TITLE, displayed on the executing screen of Tour.

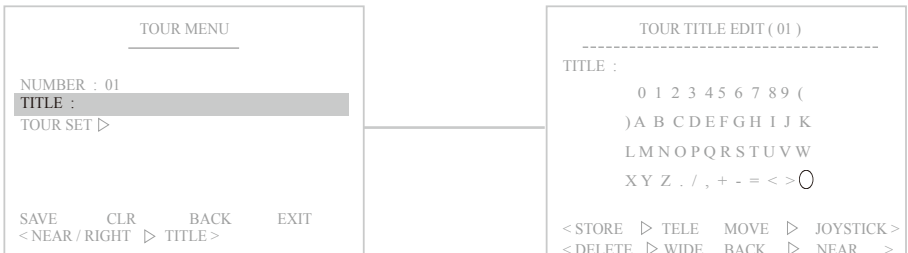

After the TITLE is set, push the NEAR button to exit.

### (3) Define the Preset position

① Move to the set-up window

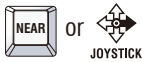

② Move and set the position



③ Set & Back

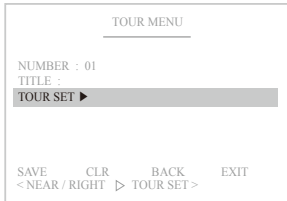

NO	PRESET	SPEED	DWELL
01	◀ 01	63	01
02	< 02	63	01
03	XX	XX	XX
04	XX	XX	XX
05	XX	XX	XX
06	XX	XX	XX
07	XX	XX	XX
08	XX	XX	XX

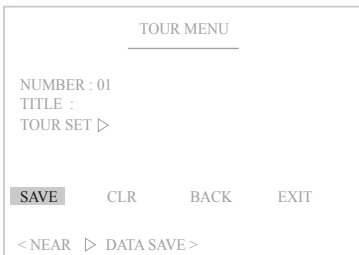
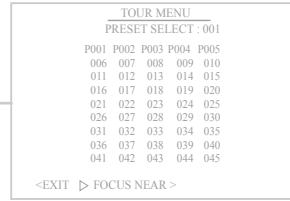

(4) "Save" above setting Pattern data to the memory.

(5) "CLR" means above setting Pattern data will not be saved and be cleared.

(6) "BACK" means it goes back to the previous menu :Motion.

(7) "EXIT" means it goes out of MENU.

## 4. 2. 3 Group

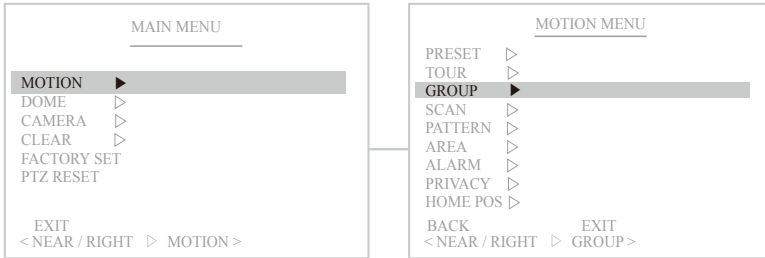

**GROUP** : You can make Max. 6 groups and call the saved tour by turn.

(1) Select the Group number

G01 : Defined Group number / 01 : Undefined Group number

Set from 1 to 6 groups.

Move :  Select : 

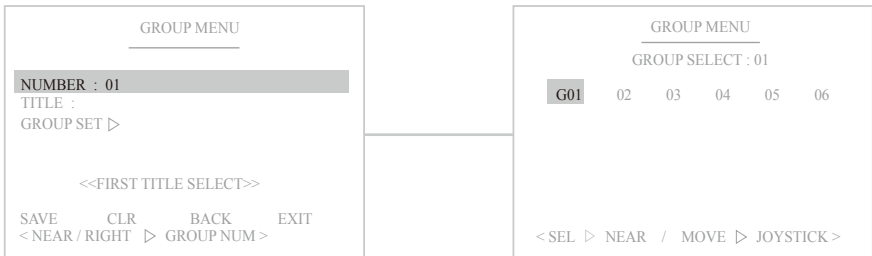

(2) Set the Group TITLE

Move :  Select :  or  Delete :  or 

It's available to set the desired TITLE, displayed on the executing screen of Group.

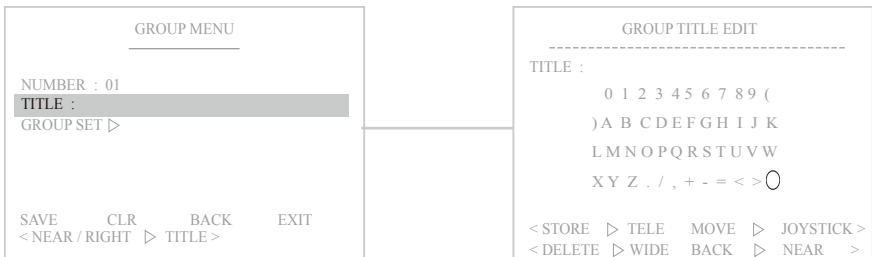

After the TITLE is set, push the NEAR button to exit.

### (3) GROUP SET

① Move to the set-up window

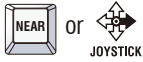

② Move and set the position



③ Set & Back

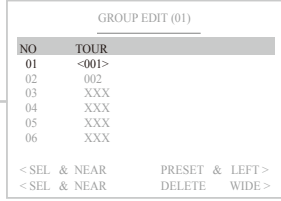
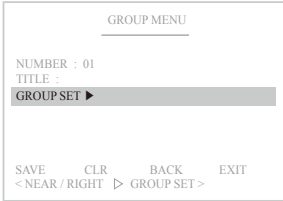

- GROUP EDIT : Set the tour from 1 to 6 of group.

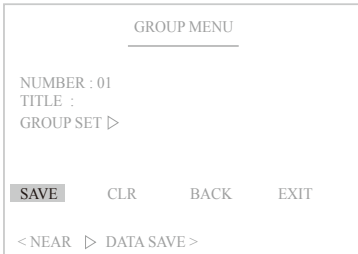

(4) "Save" above setting Pattern data to the memory.

(5) "CLR" means above setting Pattern data will not be saved and be cleared.

(6) "BACK" means it goes back to the previous menu :Motion.

(7) "EXIT" means it goes out of MENU.

## 4.2.4 Scan

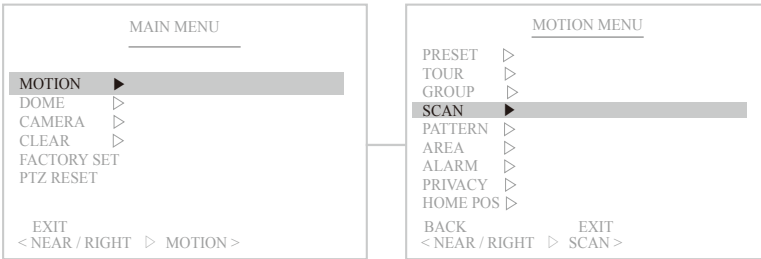

The Scan function means that the camera keeps panning between two programmed pan positions. It is also adjusts the moving speed(1~63 step). Maximum 8 Scan functions are toured in order.

### (1) Select the Scan number

S01 : Defined Scan number / 01 : Undefined Scan number

Move :  Select : 

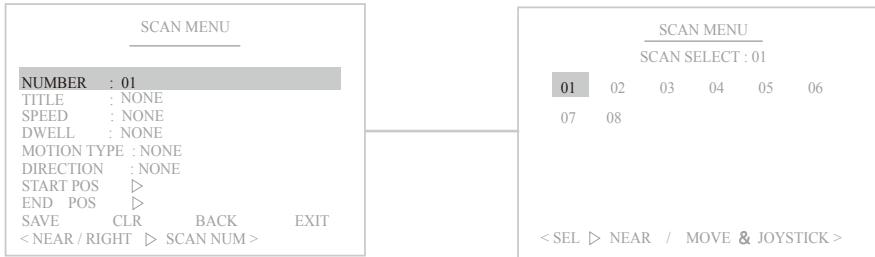

### (2) Set the Scan TITLE

Move :  Select :  or  Delete :  or 

It's available to set the desired TITLE, displayed on the executing screen of Scan.

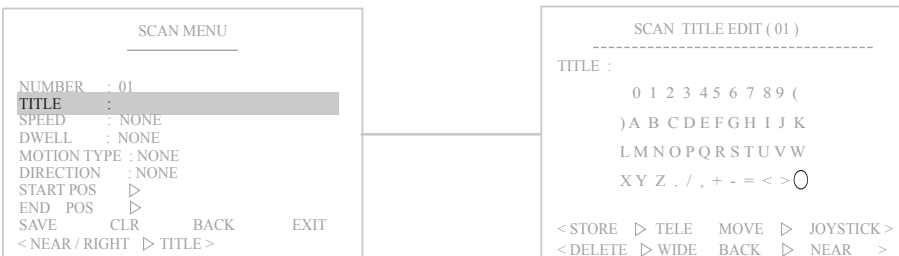

After the TITLE is set, push NEAR button to go out.

### (3) Set the Scan speed

Increase :  or  JOYSTICK

Decrease :  or  JOYSTICK

It adjusts the moving speed from 1~63 steps.

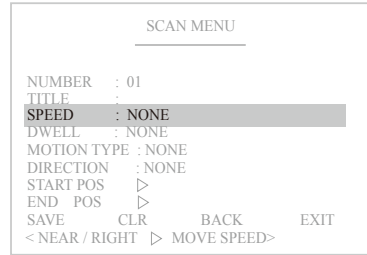

### (4) Set the Dwell Time

Increase :  or  JOYSTICK

Decrease :  or  JOYSTICK

Dwell time means the time that the camera stay at the start & end pan positions.

It's adjustable from 00~59 seconds.

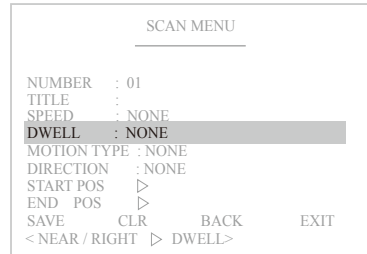

### (5) Set the Motion Type

Set PAN/TILT direction

When PAN is set, PAN SCAN is proceeded with the specified coordinate value.

When TILT is set, TILT SCAN is proceeded with the specified coordinate value.

Select :  or  Set ON :  JOYSTICK

Set OFF : 

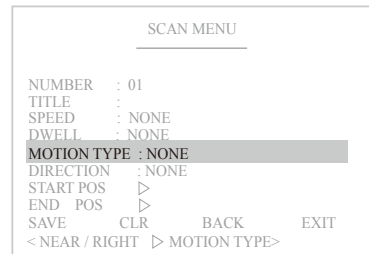

## (6) Set the Direction

PAN : Select Clock Wise or C\_Clock Wise direction

When select C\_Clock WISE, counterclockwise progression

When select Clock WISE, clockwise progression

TILT : Set the UP & DOWN.

Select :  or  Set ON : 

Set OFF : 

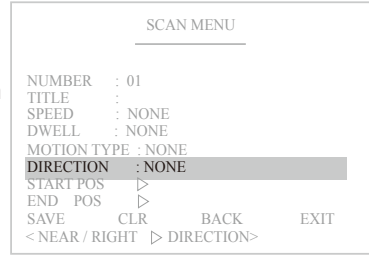

## (7) Define the Start position

① Select Start Pos menu



② Move and set the position



③ Go back

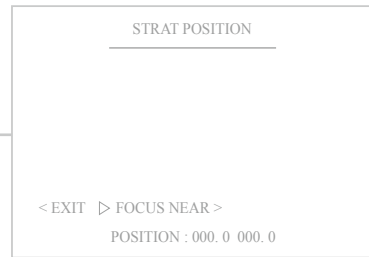
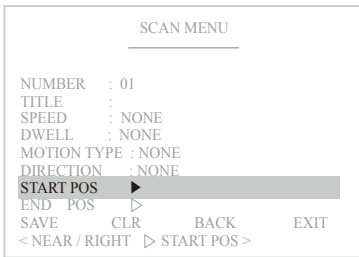

## (8) Define the End position

① Select End Pos menu



② Move and set the position



③ Go back

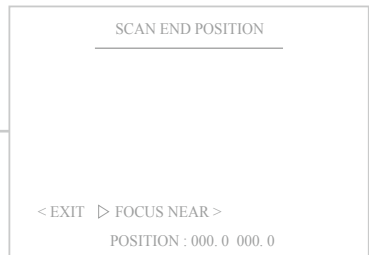
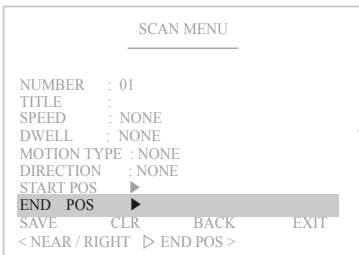

- When Motion type is PAN, Pan is available.
- When Motion type is TILT, TILT is available.

- (9) "Save" above setting Pattern data to the memory.
- (10) "CLR" means above setting Pattern data will not be saved and be cleared.
- (11) "BACK" means it goes back to the previous menu :Motion.
- (12) "EXIT" means it goes out of MENU.

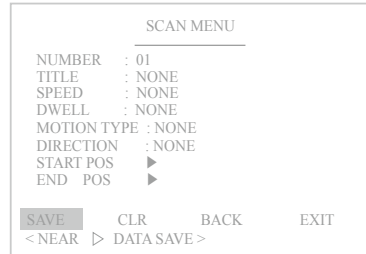

## 4. 2. 5 Pattern

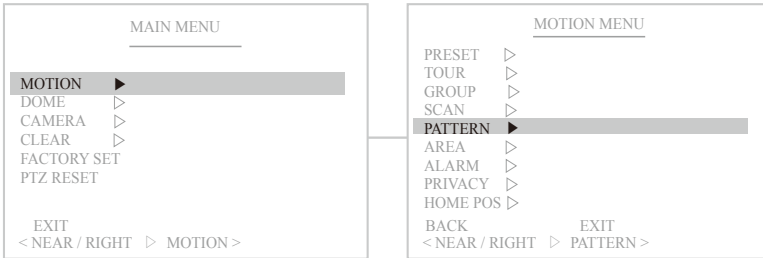

The Pattern function memorizes User's random moving path and zoom ratio. Total recording time limit is 65secs and maximum 4 Pattern functions are toured in order.

### (1) Select the Pattern number

PAT01 : Defined Pattern number / 01 : Undefined Pattern number

Move :  Select : 

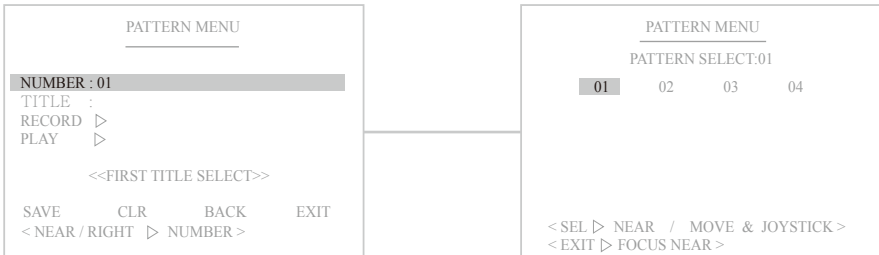

### (2) Set the Pattern TITLE

Move :  Select :  or  Delete :  or 

It's available to set the desired TITLE, displayed on the executing screen of Pattern.

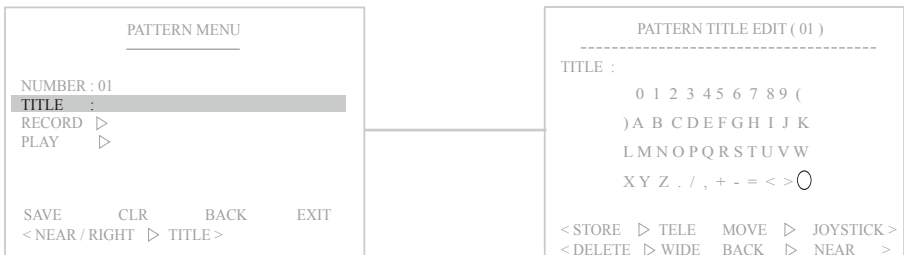

After the TITLE set, push NEAR button to go out.

(3) Record and Save the User's random Pattern data

① Select the "Record" Menu



② Move and record the pattern



③ NEAR -> EXIT

FAR -> RECORD ON

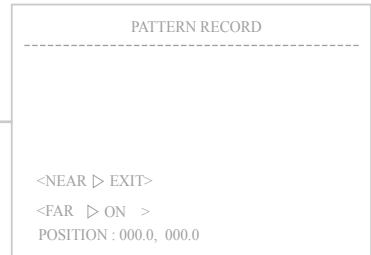
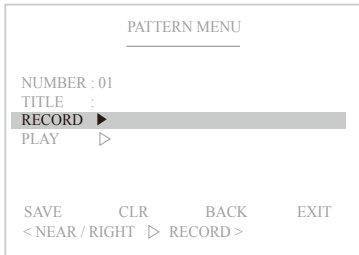

(4) Play back the recorded Pattern data



(5) "Save" above setting Pattern data to the memory.

(6) "CLR" means above setting Pattern data will not be saved and be cleared.

(7) "BACK" means it goes back to the previous menu :Motion.

(8) "EXIT" means it goes out of MENU.

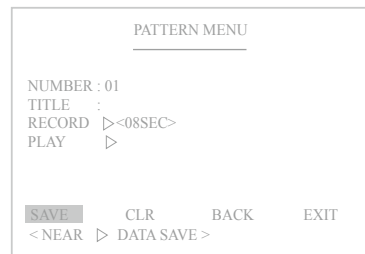

## 4.2.6 Area

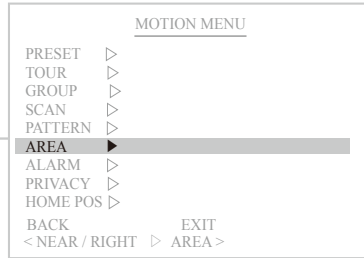
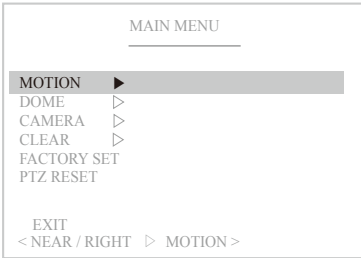

The Area function means that it displays the Area name between two programmed pan positions. Maximun 16 Area functions are toured in order.

### (1) Select the Area number

AR 01 : Defined Area number / 01 : Undefined Area number

Move :  JOYSTICK    Select : 

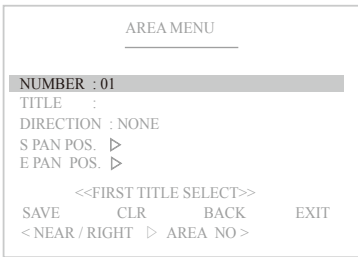

### (2) Set the Area TITLE

Move :  JOYSTICK    Select :  or  JOYSTICK    Delete :  or  JOYSTICK

It's available to set the desired TITLE, displayed on the executing screen of Area.

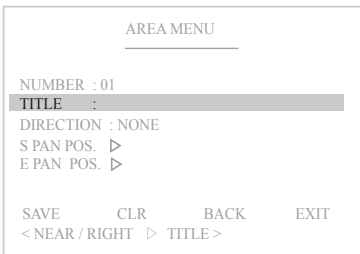

After the TITLE set, push NEAR button to go out.

### (3) Set the Direction

Select :  or  Set ON :  Set OFF : 

C\_Clock WISE is counterclockwise mark, Clock WISE is clockwise mark.

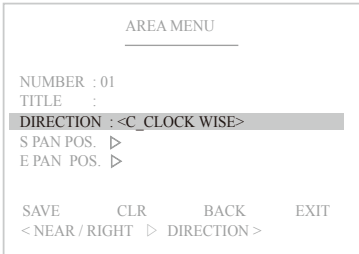

### (4) Define the Start pan position

- ① Select the "Start Pan Pos" menu
- ② Move and set the position
- ③ Set & Back

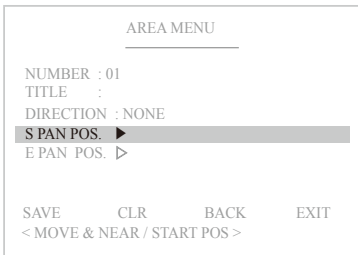

### (5) Define the END pan position

- ① Select the "END Pan Pos" Menu
- ② Move and set the position
- ③ Set & Back

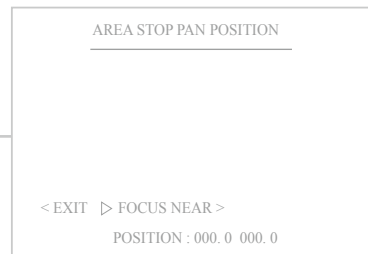
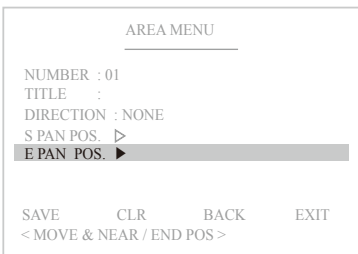

- (6) "Save" above setting Area data to the memory.
- (7) "CLR" means above setting Area data will not be saved and be cleared.
- (8) "BACK" means it goes back to the previous menu :Motion.
- (9) "EXIT" means it goes out of MENU

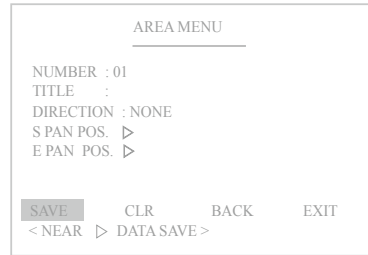

## 4.2.7 Alarm

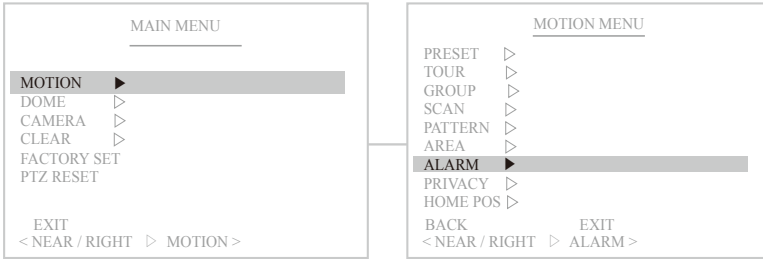

The Alarm function means that the camera moves to the programmed Preset position by the Alarm trigger. Maximum 8 Alarm functions are toured in order.

(1) Select the Alarm number

E01 : Defined Alarm number / 01 : Undefined Alarm number

Move :  Select : 

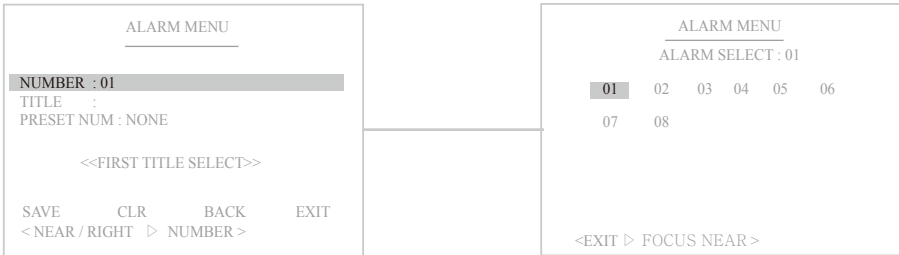

(2) Set the Alarm TITLE

Move :  Select :  or  Delete :  or 

It's available to set the desired TITLE, displayed on the executing screen of Alarm.

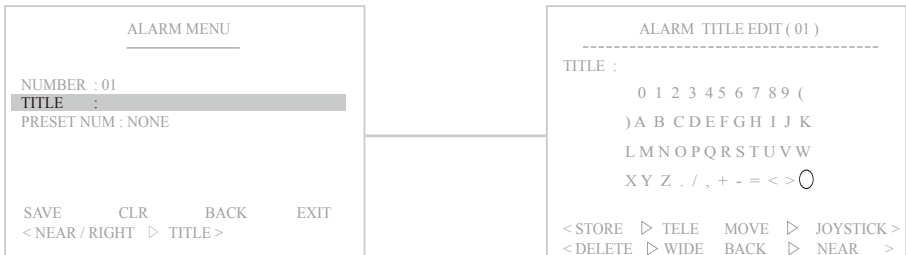

After the TITLE is set, push the NEAR button to exit.

(3) Define the Preset position with Alarm trigger

- ① Select the "Preset Num"      ② Move and set the position      ③ Set & Back

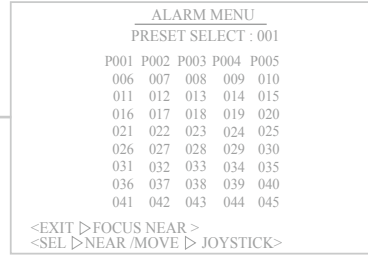
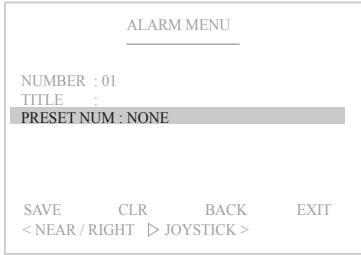
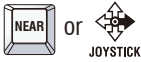

(4) "Save" above setting Alarm data to the memory.

(5) "CLR" means above setting Alarm data will not be saved and be cleared.

(6) "BACK" means it goes back to the previous menu :Motion.

(7) "EXIT" means it goes out of MENU

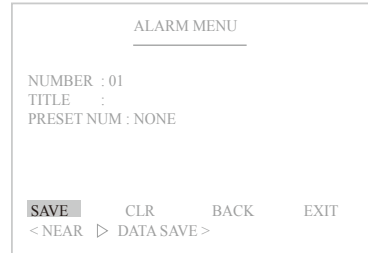

## 4. 2. 8 Privacy Zone Masking

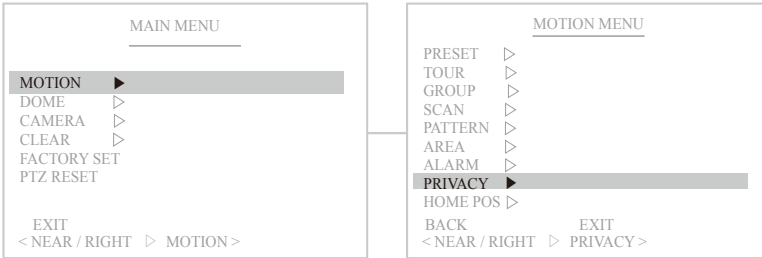

The Privacy Zone Masking function means that it sets the blocking territories to prevent camera functions for the privacy of personal reasons. Maximum of 8 Privacy Zone Masking functions are toured in order.

(1) Select the Privacy Zone number

R01 : Defined Alarm number / 01 : Undefined Alarm number

Move :  Select : 



(2) Mask set

Move :  Select :  or  Delete :  or 

It's available to set the desired position and size of the blocking territories freely.



After the Privacy Zone is set, push the NEAR button to go out.

- (3) "Save" above settings of Privacy Zone data to the memory.
- (4) "CLR" means above setting of Privacy Zone data will not be saved and be cleared.
- (5) "BACK" means it goes back to the previous menu :Motion.
- (6) "EXIT" means it goes out of MENU.

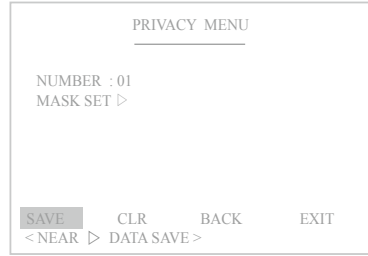

## 4. 2. 9 Home Position

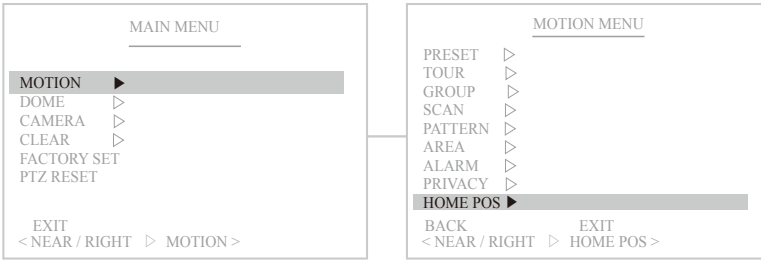

Home Position : Move to selected home position.(255+SET)

### (1) Home Position ON/OFF setting

Move :  Select : 

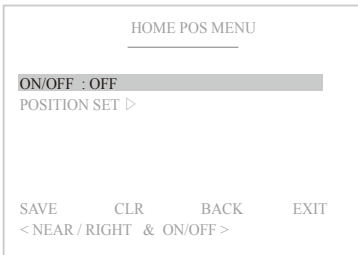

### (2) Home Position SET

Move :  Select : 



## 4.3 Dome Setting



Pan, Tilt, Zoom motion is adjustable in the “Dome Setting” Menu.

### 4.3.1 Set the Dome camera title

Move :  JOYSTICK    Select :  or  JOYSTICK    Delete :  or  JOYSTICK

It's available to set the desired camera title.



After the TITLE is set, push NEAR button to exit.

### 4.3.2 Speed by Zoom ON/OFF Set

Adjust PAN/Tilt Speed by Zoom ration.  
 (Available to check with max zoom rate.)

Select :  JOYSTICK or     Set ON :  JOYSTICK

Set OFF : 

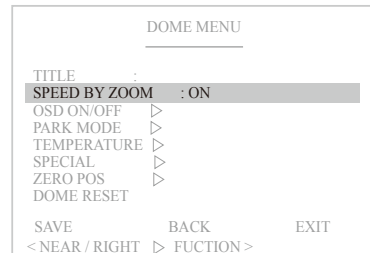

### 4. 3. 3 OSD ON/OFF Set

You can select the OSD ON to shown on the screen or clear by selecting OFF in this function.

Select :  or  Set ON :  Set OFF : 

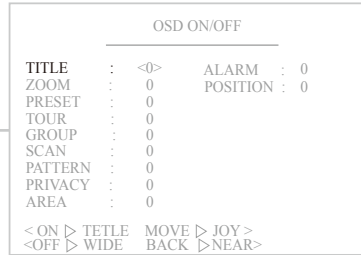
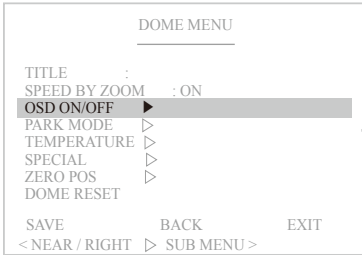

### 4. 3. 4 PARK MODE

This function enables to locate the camera to specific position automatically if operator doesn't operate the controller for a while.

 or 

- ON/OFF : Select ON/OFF
- TIME : Select 10 sec~1 HOUR
- MOTION : Set PRESET / TOUR / GROUP / SCAN / PATTERN
- NUMBER
- PRESET : 1~255
- TOUR : 1~8
- GROUP : 1~6
- SCAN : 1~8
- PATTERN : 1~4

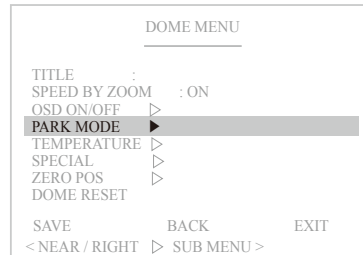

### 4.3.5 TEMP MODE

It shows you the current temperature and you can also set the value manually. The compulsory Fan & Heater operation is a useful function to remove humidity.

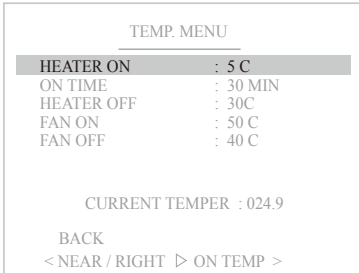
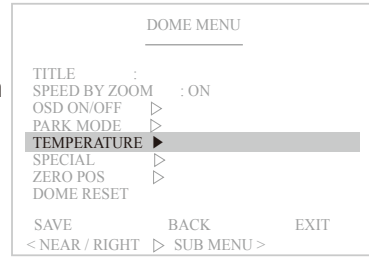

#### (1) HEATER ON

Set the operating temperature of the heater. (0~70 °C)

Select :  or  Set ON : 

Set OFF : 

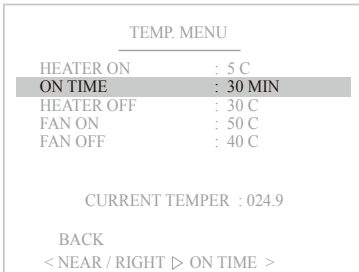

#### (2) ON TIME

Set the operating time of the heater.  
- By 10min. (10~60 min.)

Select :  or  Set ON : 

Set OFF : 

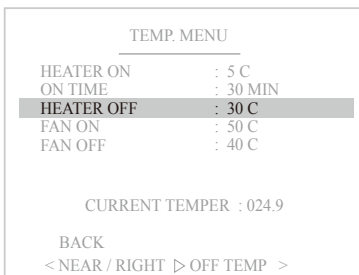

#### (3) HEATER OFF

Set the temperature of heater OFF. (0~70 °C)

Select :  or  Set ON : 

Set OFF : 

TEMP. MENU	
HEATER ON	: 5 C
ON TIME	: 30 MIN
HEATER OFF	: 30 C
<b>FAN ON</b>	<b>: 50 C</b>
FAN OFF	: 40 C
CURRENT TEMPER : 024.9	
BACK	
< NEAR / RIGHT ▷ FAN ON >	

#### (4) FAN ON

Set the operating temperature of the Fan. (0~70℃)

Select :  or  Set ON : 

Set OFF : 

TEMP. MENU	
HEATER ON	: 5 C
ON TIME	: 30 MIN
HEATER OFF	: 30 C
FAN ON	: 50 C
<b>FAN OFF</b>	<b>: 40 C</b>
CURRENT TEMPER : 024.9	
BACK	
< NEAR / RIGHT ▷ FAN OFF >	

#### (5) FAN OFF

Set the temperature of Fan OFF. (0~70℃)

Select :  or  Set ON : 

Set OFF : 

## 4.3.6 Special

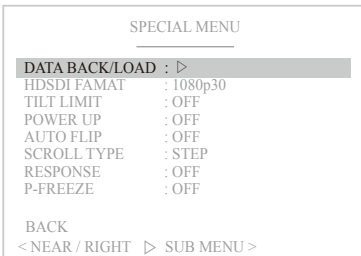
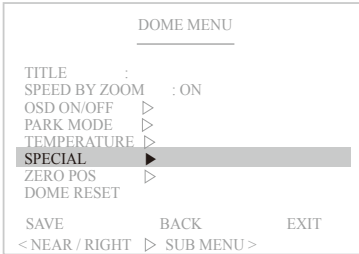

### (1) DATA BACK/LOAD

Backup or load the Motion, Camera and PTZ Setting Data

Select :  or  JOYSTICK

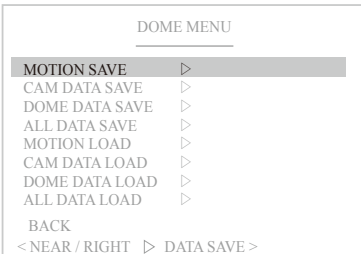

### - DATA BACK/LOAD Sub Menu Tree

- MOTION SAVE : Save the current Motion Data
- CAM DATA SAVE : Save the current Camera Data
- DOME DATA SAVE : Save the current PTZ Data
- ALL DATA SAVE : Save above all 3 Datas.
- MOTION LOAD : Apply the saved Motion Data
- CAM DATA LOAD : Apply the saved Camera Data
- DOME DATA LOAD : Apply the saved PTZ Set Data
- ALL DATA LOAD : Apply the saved above all 3 Datas.

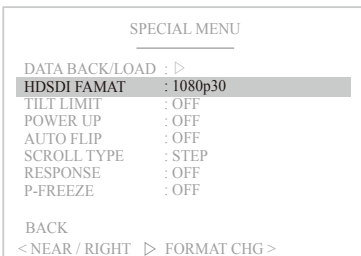

### (2) HDSI FORMAT

- 1080p/30(25)fps / 720p/60(50)fps
- 1080p/30(25)fps / 1080p/60(50)fps / 720p/30(25)fps / 720p/60(50)fps

- \* Video format setting depends upon the models.
- \* Video format is not applied for analogue models.

Select :  or  Set ON :  JOYSTICK

Set OFF : 

SPECIAL MENU	
DATA BACK/LOAD	: ▷
HDSDI FAMAT	: 1080p30
<b>TILT LIMIT</b>	: <b>OFF</b>
POWER UP	: OFF
AUTO FLIP	: OFF
SCROLL TYPE	: STEP
RESPONSE	: OFF
P-FREEZE	: OFF
BACK	
< NEAR / RIGHT ▷ TILT LIMIT >	

### (3) TILT LIMIT

Set tilt stop angle. : off ~15°

Select :  or  Set ON : 

Set OFF : 

SPECIAL MENU	
DATA BACK/LOAD	: ▷
HDSDI FAMAT	: 1080p30
TILT LIMIT	: OFF
<b>POWER UP</b>	: <b>OFF</b>
AUTO FLIP	: OFF
SCROLL TYPE	: STEP
RESPONSE	: OFF
P-FREEZE	: OFF
BACK	
< NEAR / RIGHT ▷ PWR UP SET >	

### (4) POWER UP

When this function is ON, the camera memorizes the latest action and restores, it from sudden power failure.

Select :  or  Set ON : 

Set OFF : 

SPECIAL MENU	
DATA BACK/LOAD	: ▷
HDSDI FAMAT	: 1080p30
TILT LIMIT	: OFF
POWER UP	: OFF
<b>AUTO FLIP</b>	: <b>OFF</b>
SCROLL TYPE	: STEP
RESPONSE	: OFF
P-FREEZE	: OFF
BACK	
< NEAR / RIGHT ▷ AUTOFLIP >	

### (4) AUTO FLIP

- OFF: TILT movement ranges from 0 ~90°
- AUTO: When TILT move to 90°, PAN 180° automatically reversed moved
- DIGITAL: TILT movement ranges from 0 ~ 180° (Reversal of Image with 90° degree angle.)

Select :  or  Set ON : 

Set OFF : 

SPECIAL MENU	
DATA BACK/LOAD	: ▷
HDSDI FAMAT	: 1080p30
TILT LIMIT	: OFF
POWER UP	: OFF
AUTO FLIP	: OFF
<b>SCROLL TYPE</b>	: <b>STEP</b>
RESPONSE	: OFF
P-FREEZE	: OFF
BACK	
< NEAR / RIGHT ▷ TYPE >	

### (5) SCROLL TYPE

Set the cursor progress  
STEP : by 1 STEP  
AUTO : Continuous scroll

Select :  or  Set ON : 

Set OFF : 

SPECIAL MENU	
DATA BACK/LOAD	: ▷
HDSDI FAMAT	: 1080p30
TILT LIMIT	: OFF
POWER UP	: OFF
AUTO FLIP	: OFF
SCROLL TYPE	: STEP
<b>RESPONSE</b>	<b>: OFF</b>
P-FREEZE	: OFF
BACK	
< NEAR / RIGHT ▷ ON/OFF >	

### (7) RESPONSE TXD

Tx communication line to transfer the unique value of protocol response.  
 (Use this function when the protocol is pelco-D 5.0 EZ.)

Select :  or  Set ON : 

Set OFF : 

SPECIAL MENU	
DATA BACK/LOAD	: ▷
HDSDI FAMAT	: 1080p30
TILT LIMIT	: OFF
POWER UP	: OFF
AUTO FLIP	: OFF
SCROLL TYPE	: STEP
RESPONSE	: OFF
<b>P-FREEZE</b>	<b>: OFF</b>
BACK	
< NEAR / RIGHT ▷ ON/OFF >	

### (8) P-FREEZE

The screen is stopped while the camera is operating presetfunction.

Select :  or  Set ON : 

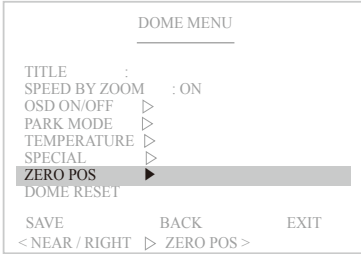

Set OFF : 

### 4. 3. 7 ZERO POS

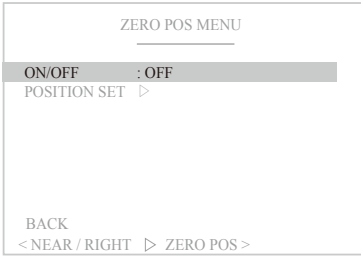

When select ON, the zero position is changeable.  
 POSITION change 000.0 / 000.0 value.



Select :  or  Set ON : 

Set OFF : 

### 4. 3. 8 DOME RESET

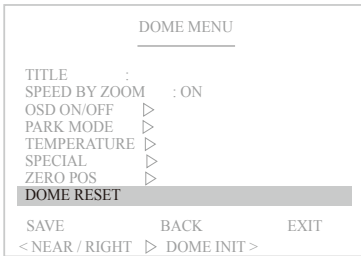

DOME MENU initialization function.

## 4.4 Clear Setting

Clears the PTZ position and function value.

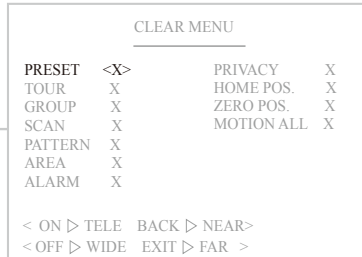

Select :  or 

Set ON : 

Set OFF : 

## 4.5 Factory set

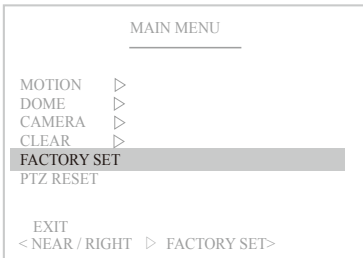

Clear the DOME, CAMERA and MOTION setting value.



Restore setting values to the factory default.  
 All existing setting value will be erased.

## 4.6 PTZ Reset

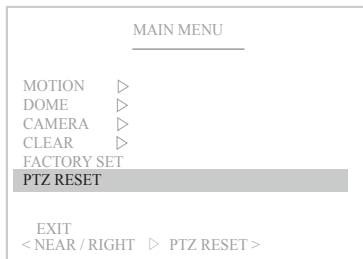

It is a reset function.

## 4.7 Other Quick Operating Guide

1. 248 + Long Preset : Heater/Fan ON (Turn on the compulsive operating: One hour)
2. 249 + Long Preset : Heater/Fan OFF (Turn off the compulsive operating)
3. 250 + Long Preset : Camera Factory Set
4. 251 + Long Preset : Camera Lens Init
5. 255 + Long Preset : PTZ Information

# 5. SPECIFICATION

## 5.1 Mechanism Specification

### 5.1.1 MECHANICAL

- Pan : 360° Continuous Pan, 0.1° to 120°/sec.
- Pan Preset Speed : 360°/sec, ± 0.1° Accuracy
- Tilt : 0.1° to 120°/sec.
- Tilt Preset Speed : 250°/sec, ± 0.05° Accuracy
- Weight : PACKING 9.4Kg
- Dimensions Set : 237 (Ø) x 310(mm)-148(Ø)DOME

### 5.1.2 ENVIRONMENTAL

- Construction : Aluminum
- Ingress Protection : IP66 (Outdoor Housing)
- Operating Temp : Outdoor -40°C to 60°C (-40° F to 140° F)/ with 35W Heater
- Humidity : 0% to 90% (non-condensing)
- Fan operate : 50°C on , 40°C off
- Heater operate : 20°C on , 30°C off

### 5.1.3 FUNCTIONS

- Preset : 255 points, less than 0.1° accuracy
- Tour : 8 programmable
- Pattern : 4 patterns for 60 second.
- Group : 6 group(Max.6 Tours are programmable in each Group)
- Scan : 8 (programmable speed and diagonal scan)
- Privacy Zone : 8 block with title (Mask)
- ID Address : Up to 255 selectable ID (Rotary switch)
- Data Communication Control : RS-485 / RS-422
- Protocol : Multiple protocol (PELCO D/P, WTX)
- Baud rate : 2400, 4800, 9600, 19200, 38400, 57600, 115200 bps selectable
- Alarm : 8 alarm
- Display : 16 Area title
- Auto Flip : Off / AUTO / DIGITAL

### 5.1.4 ELECTRICAL

- Power : AC21 ~26V 60Hz / 50Hz(Power adaptor not included)
- Power Consumption : 12W / MAX 75W(Fan & Heater)
- Camera Power Consumption : 18.0W
- Heater Power Consumption : 35W
- RS-422, 485 : Dip Switch setting

### 5.1.5 USER CONNECTIONS

- Data communication connection : RS-422, 485 + / - Optional Control Data
- HD-SDI connection : BNC
- Alarm Inputs : 8 Programmable
- Relay : 2 Dry Contact Output Rating: 2A @30VAC

## 6. DIMENSION

### 6.1 DIMENSION

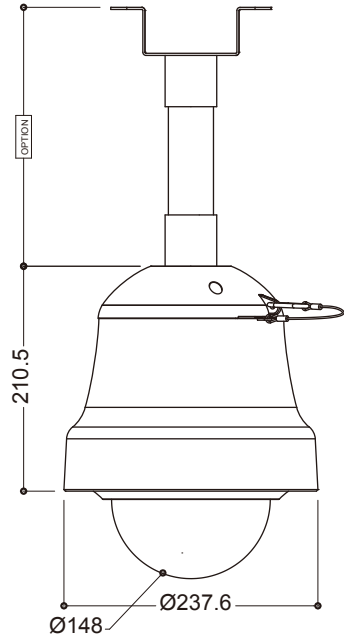
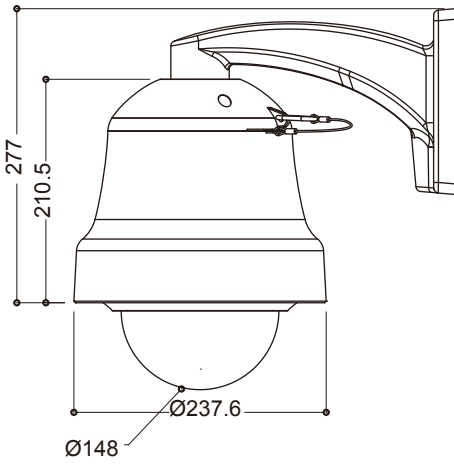

# 7. CONFIGURATION

## 7.1 Connecting to Keyboard with DVR

